

- BANDS ARE CLEAN FINISHED AND MATTE TRICOT
- CORD AND CORD STOPPER TO CINCH SLEEVES
- CHAINSTITCH
- SHORTS LINED AND CLEAN FINISHED

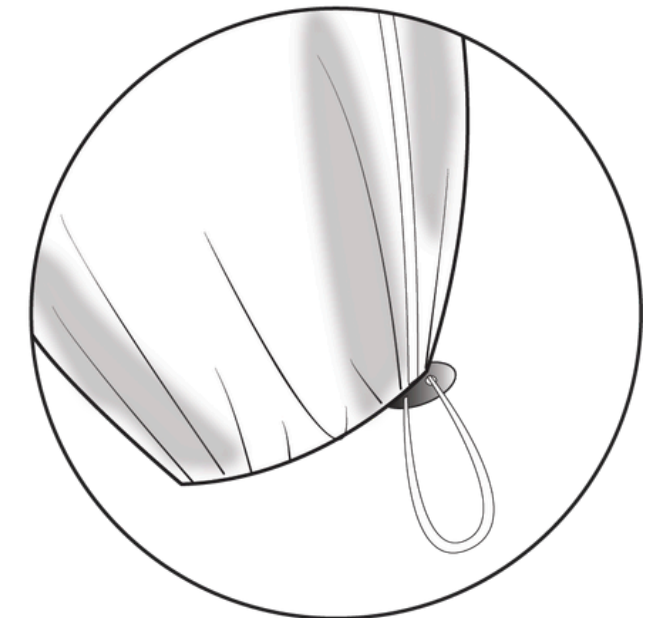

NYLON TASLAN / MATTE TRICOT

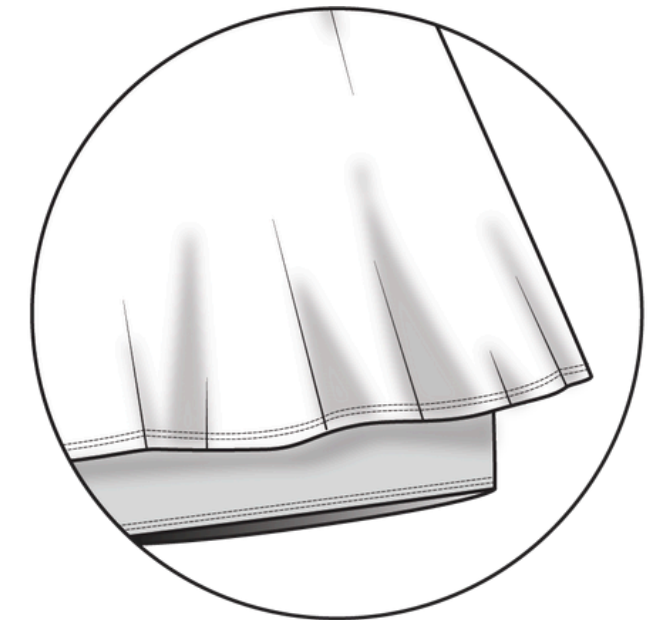
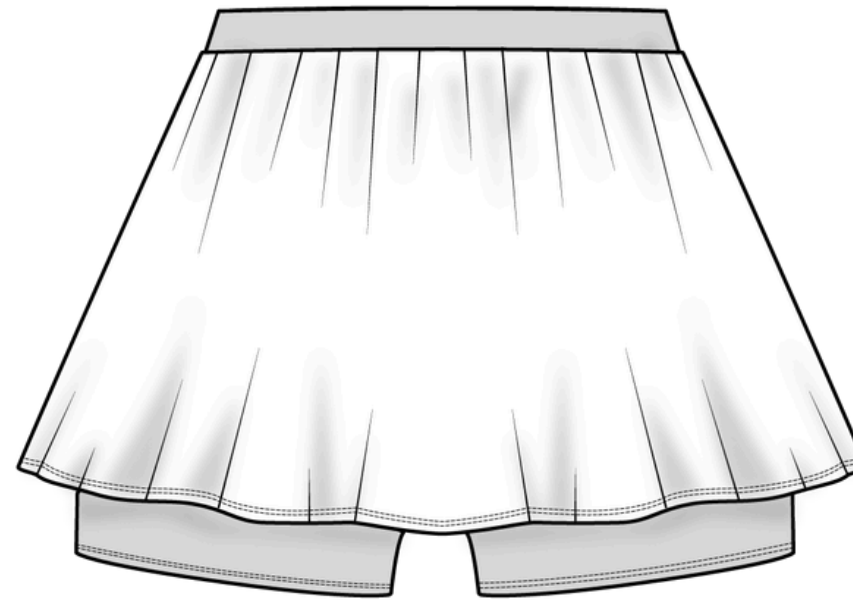
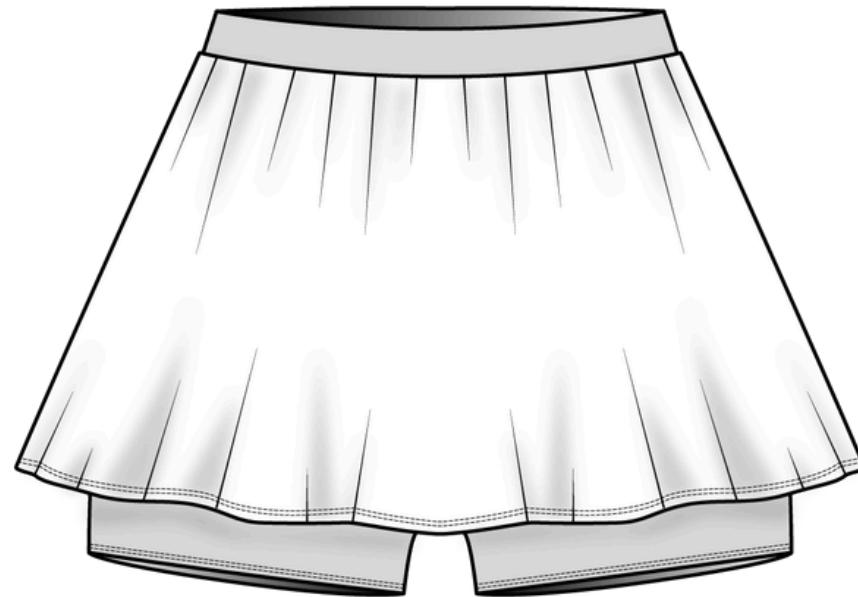

- **OVERSIZED FIT AND 3/4 SLEEVE**
- **WAISTBAND AND UNDER SHORTS ATTACHED TO SKIRT**
- **WAISTBAND AND SHORTS ARE MATTE TRICOT**

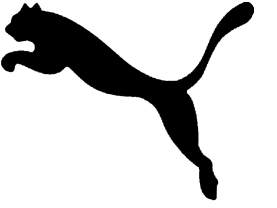

HEAVY WEIGHT COTTON JERSEY / PEACH SKIN JERSEY / MATTE TRICOT

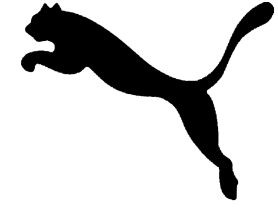
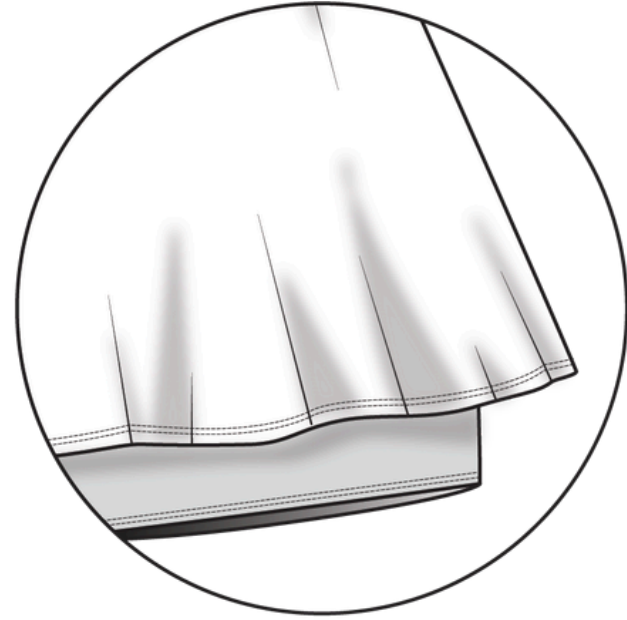
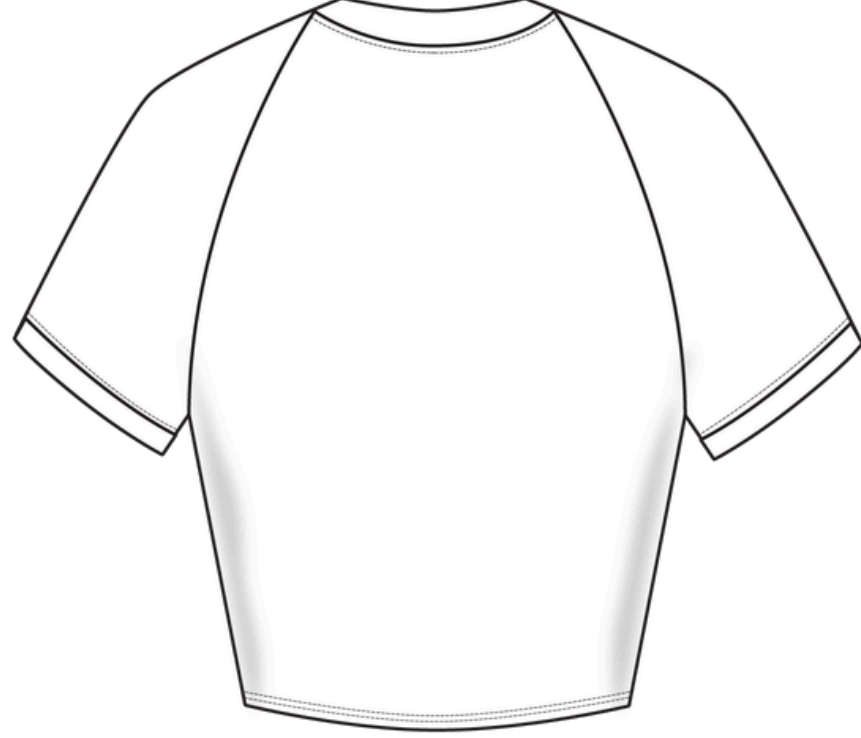
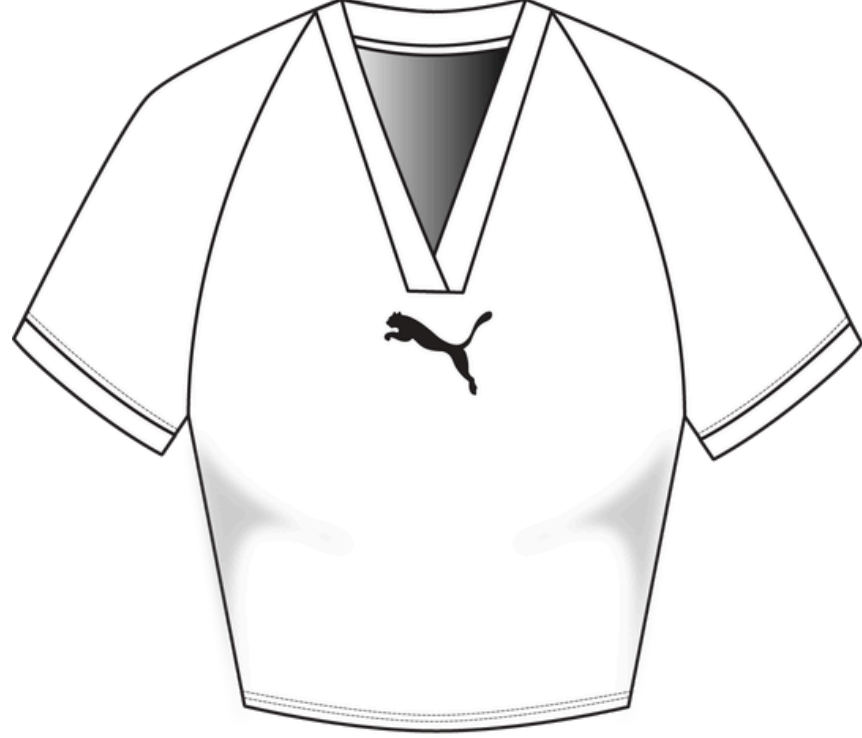

HEAVY WEIGHT COTTON JERSEY / PEACH SKIN JERSEY / MATTE TRICOT

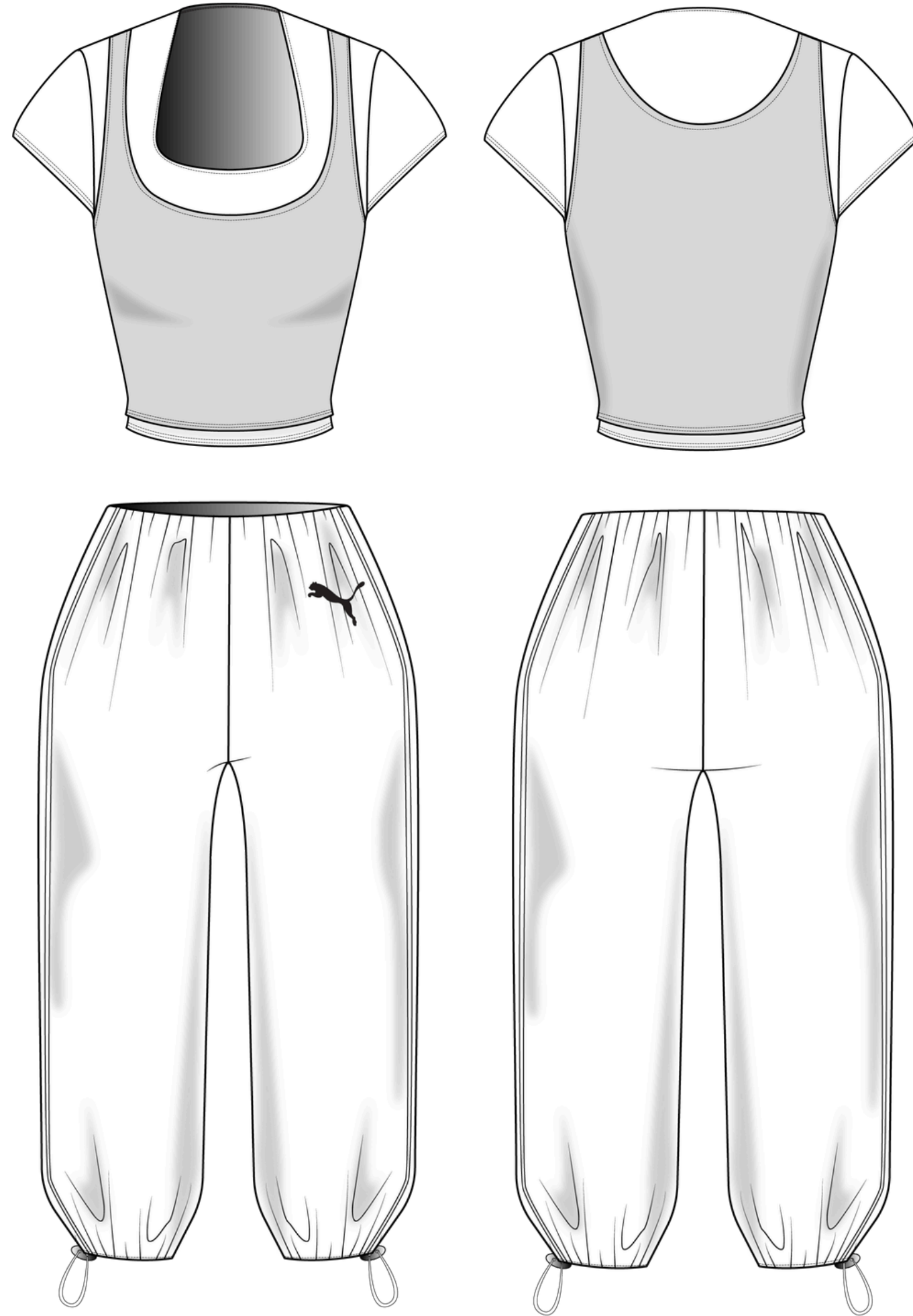
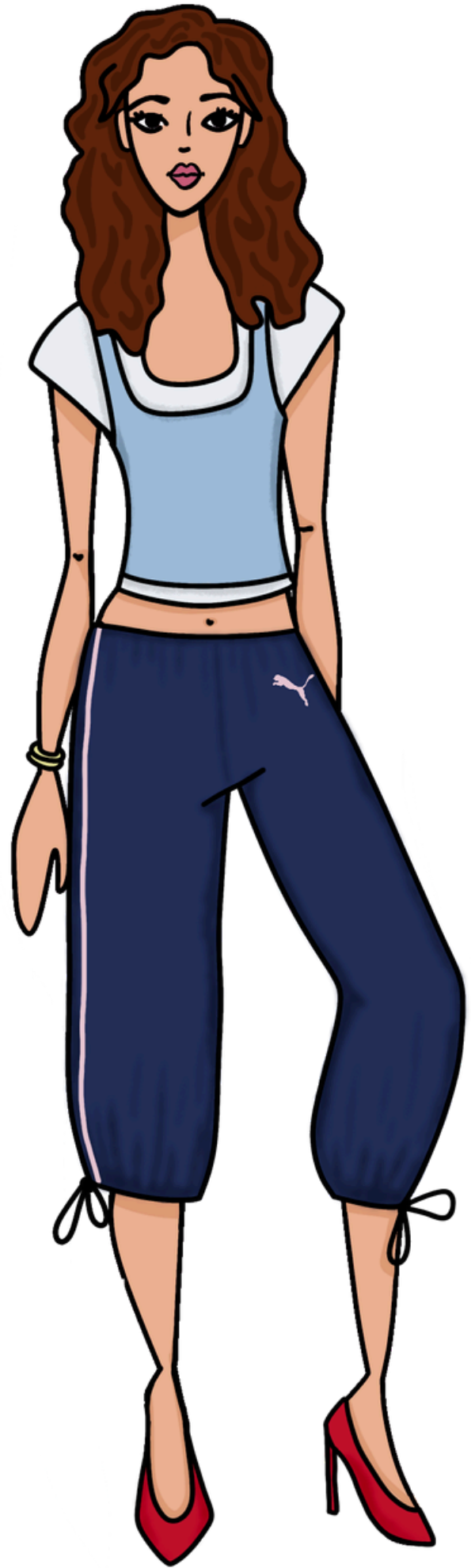

- LAYERED TANK TOP ATTACHED TO T-SHIRT
- CORD AND CORD STOPPER TO CINCH PANTS
- CORD STOPPER CAN BE RELEASED TO TURN CAPRIS INTO FULL-LENGTH PANTS
- SINGLE STITCH IS CHAIN STICH
- PANTS HAVE HIDDEN ELASTIC BAND

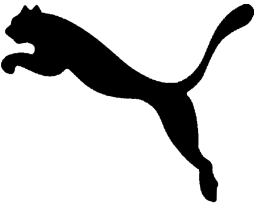

JERSEY KNIT / NYLON TASLAN

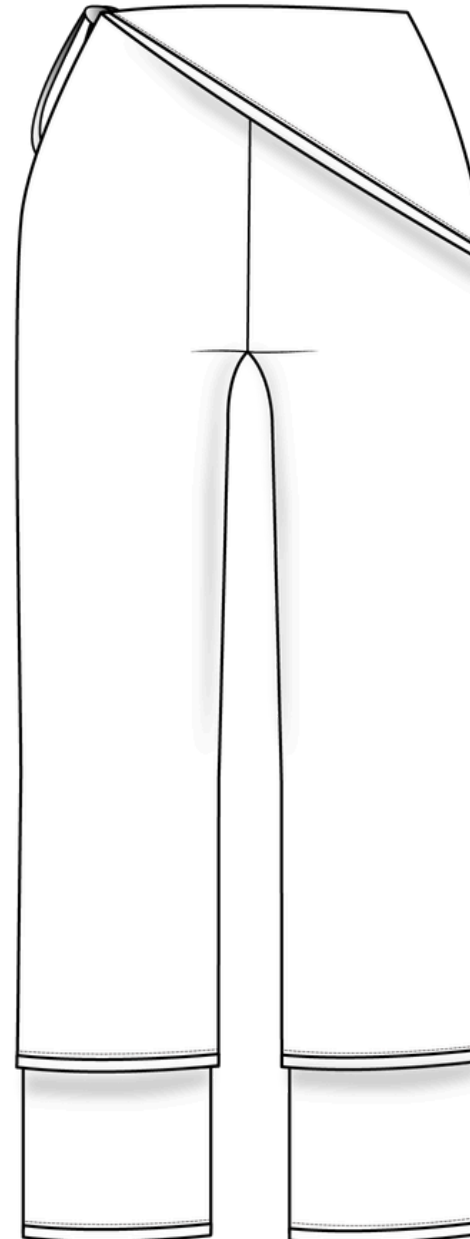
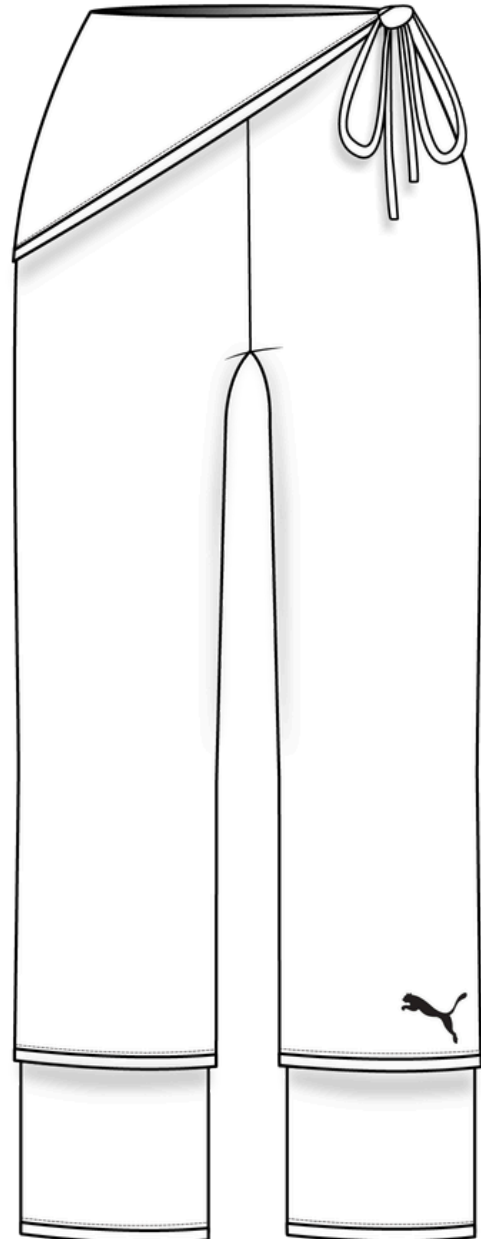

- CROP FIT AND DEEP V-NECK JERSEY
- LAYERED SKIRT OVER PANTS; TIES TO HOLD IN PLACE ON WEARER'S LEFT
- LAYERED PANT HEM
- PANTS HAVE HIDDEN ELASTIC BAND
- SINGLE STITCH IS CHAINSTITCH

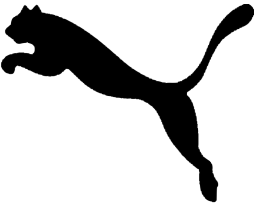
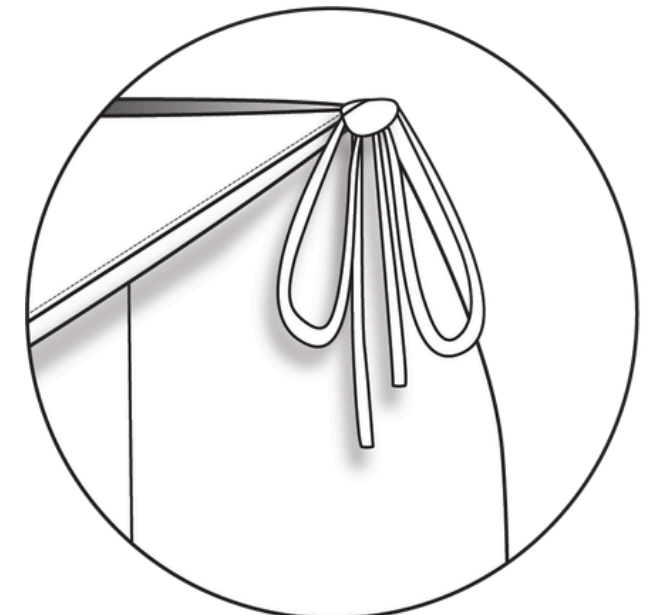

MAX-DRI PERFORMANCE JERSEY

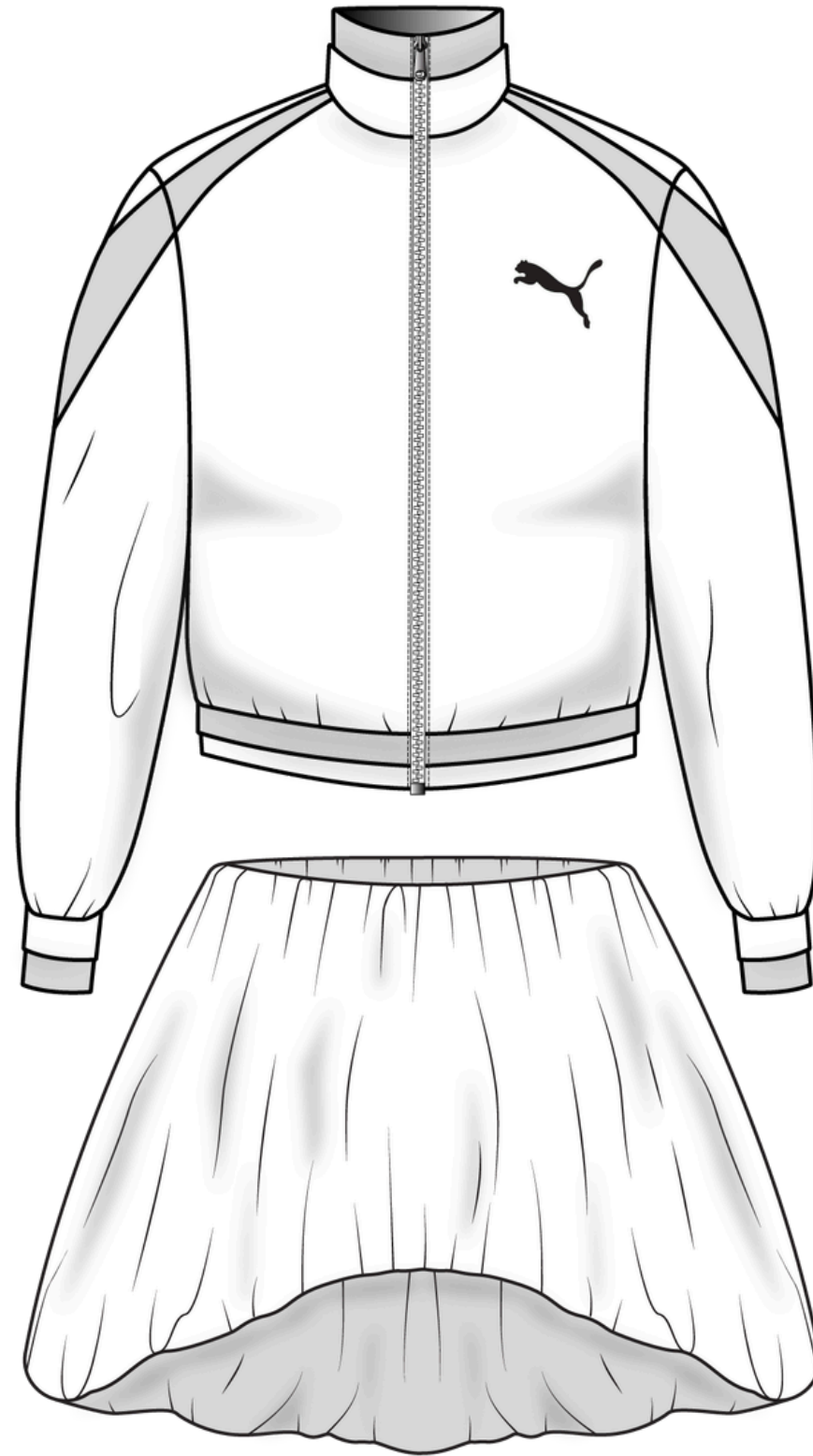

- **DOUBLE LAYERED TURTLENECK, CUFFS, AND BANDED HEM**
- **HIGH-LOW BUBBLE SKIRT IS REVERSIBLE AND CLEAN FINISHED**
- **SKIRT HAS HIDDEN ELASTIC BAND**

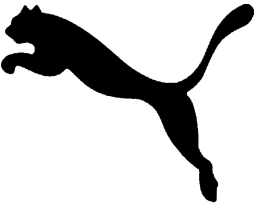
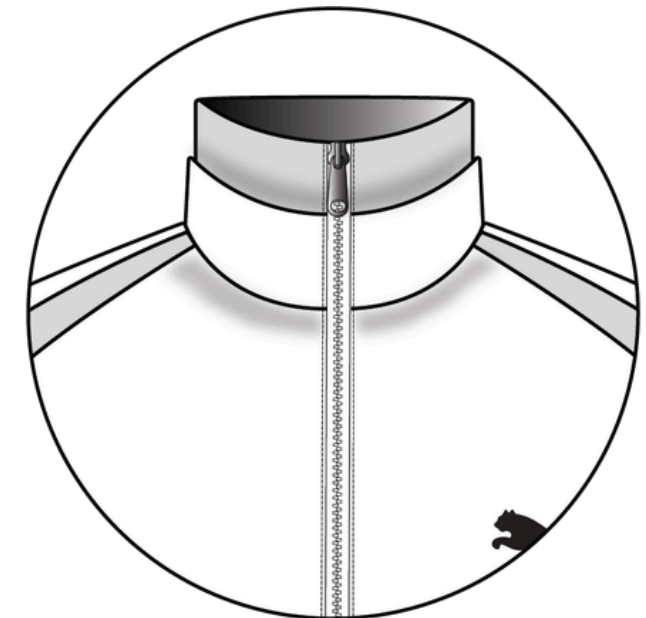

MAX-DRI PERFORMANCE JERSEY / NYLON TASLAN

Brand: Puma	Style #: 202601
Designer: Styra Goldblatt	Style Name: Soft Motion Tennis Skirt
STYLE INFORMATION	
Season: Spring/Summer 2027	
Sample Size: S	
Fabric(s): Peach Skin Jersey & Matte Tricot	
Fiber Content: 86% polyester 14% elastane; 80% nylon 20% elastane	
Color / Print: Victory Yellow, Cherry Stride, Studio Pink	
Description: Tennis skirt with built in biker shorts	

Brand: Puma

Style #: 202601

Designer: Styra Goldblatt

Style Name: Soft Motion Tennis Skirt

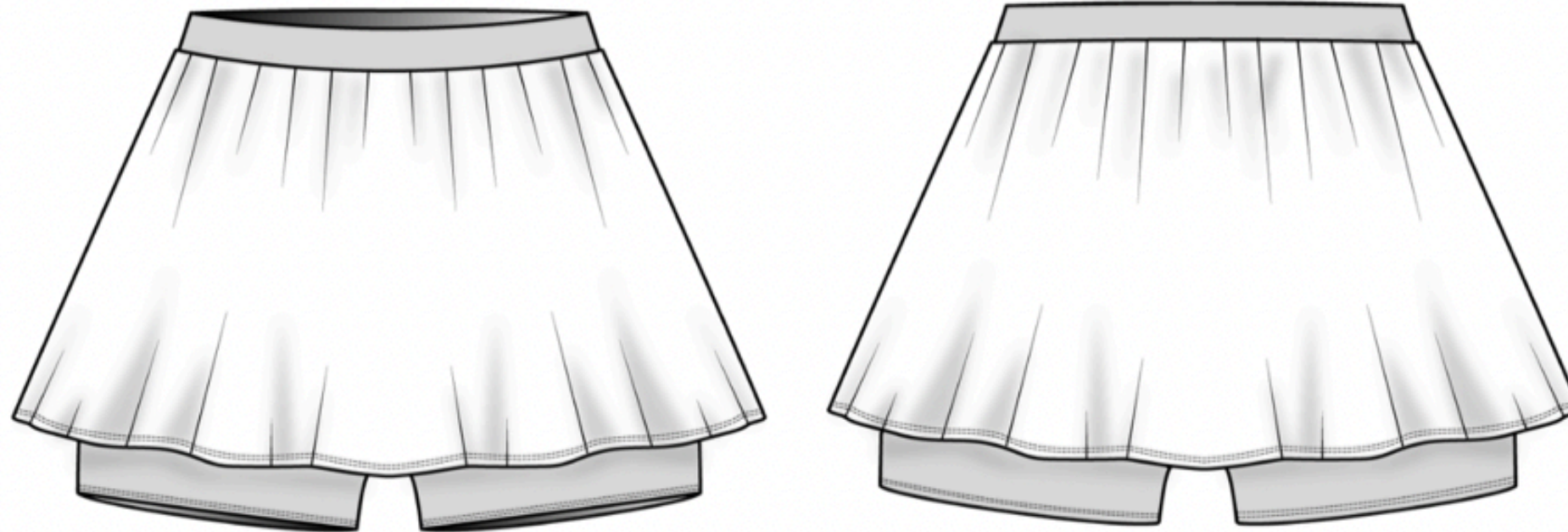

- **WAISTBAND AND UNDER SHORTS ATTACHED TO SKIRT**
- **WAISTBAND AND SHORTS ARE MATTE TRICOT**

Brand: Puma				Style #: 202601		
Designer: Styra				Style Name: Soft Motion Tennis Skirt		
BILL OF MATERIALS						
Fabric	Mill/Supplier & Ref #	Content	Weight (gsm, g/m2, oz)	Cutable Width	Color	Placement
<i>Peach Skin Jersey</i>	<i>Eysan Fabrics #21334</i>	<i>86% Polyester / 14% Black Elastane</i>	<i>290 g/m2</i>	<i>58"</i>	<i>Victory Yellow</i>	<i>Body</i>
<i>Matte Tricot</i>	<i>Spandex by Yard #FM-60/ FM-65</i>	<i>80% Nylon / 20% Spandex</i>	<i>200 g/m2</i>	<i>58"</i>	<i>Cherry Stride / Studio Pink</i>	<i>Waistband & Shorts</i>

POM #/ code	POM	Spec for S
1	CONTOUR WAIST TOP EDGE	27"
2	CONTOUR WAIST BOTTOM SEAM	29"
3	WAISTBAND HEIGHT	1"
4	HIGH HIP 3 1/2" FROM WAISTBAND	34"
5	SWEEP	79"
6	CF LENGTH (INCLUDING WAISTBAND)	11.5"
7	CB LENGTH (INCLUDING WAISTBAND)	12.5"
8	HIGH HIP ON BUILT-IN SHORTS	29"
9	INSEAM	5"
10	LEG OPENING	14"

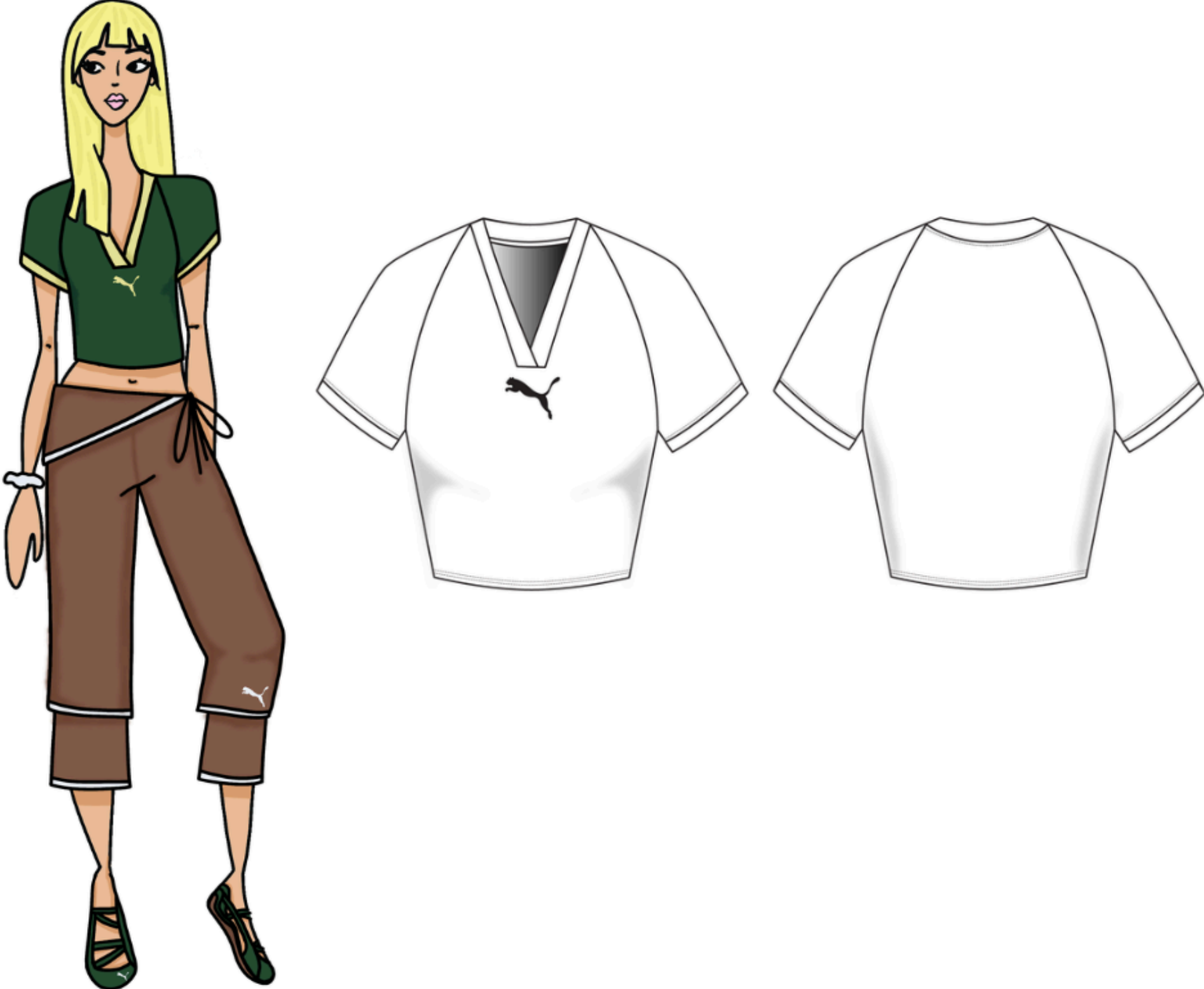
Brand: Puma	Style #: 202602
Designer: Styra Goldblatt	Style Name: Soft Motion Cropped Jersey
<p>STYLE INFORMATION</p>	
<p>Season: Spring/Summer 2027</p>	
<p>Sample Size: S</p>	
<p>Fabric(s): Max-Dri Performance Jersey</p>	
<p>Fiber Content: 88% Polyester 12% Spandex</p>	
<p>Color / Print: Green Green, Victory Yellow</p>	
<p>Description: Cropped Soccer Jersey</p>	

Brand: Puma

Style #: 202602

Designer: Styra Goldblatt

Style Name: Soft Motion Cropped Jersey



- CROP FIT AND DEEP V-NECK JERSEY
- COVER STITCH AND CHAINSTITCH

Brand: Puma				Style #: 202602		
Designer: Styra Goldblatt				Style Name: Soft Motion Cropped Jersey		
BILL OF MATERIALS						
Fabric	Mill/Supplier & Ref #	Content	Weight (gsm, g/m2, oz)	Cutable Width	Color	Placement
<i>Max-Dri Performance Jersey</i>	<i>Mood Fabrics #311385</i>	<i>95 organic cotton /5 span</i>	<i>210 g/m2</i>	<i>58"</i>	<i>Grey heather</i>	<i>Body</i>

POM #/ code	POM	Spec for S
1	CHEST 1" BELOW ARMHOLE	15"
2	ACROSS SHOULDER	5 1/4"
3	ACROSS FRONT 5" DOWN FROM HPS	10 1/2"
4	ACROSS BACK 5" DOWN FROM HPS	12"
5	WAIST @ 16" DOWN FROM HPS	26"
6	SWEEP	28"
7	FRONT LENGTH HPS TO HEM	17"
8	BICEP 1" BELOW ARMHOLE	5 3/4"
9	SLEEVE LENGTH FROM SHOULDER	8"
10	SLEEVE OPENING	12"
11	NECK WIDTH EDGE TO EDGE	5 3/4"
12	FRONT NECK DROP FROM HPS	6"
13	WIDTH SLEEVE @ NECKLINE	1"
14	HPS TO BOTTOM OF ARMHOLE	8 1/2"

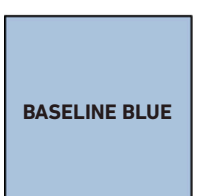
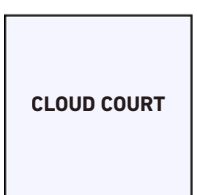

SOFT MOTION PUFF SHORTS



MIDNIGHT MOTION



STUDIO PINK

SOFT MOTION TENNIS SKIRT



VICTORY YELLOW



BASELINE BLUE



CHERRY STRIDE

SOFT MOTION REVERSIBLE BUBBLE SKIRT

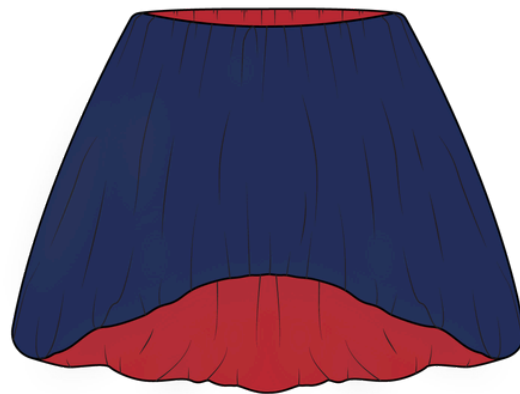

MIDNIGHT MOTION/CHERRY STRIDE



CLOUD COURT/STUDIO PINK

SOFT MOTION LAYERED PANTS

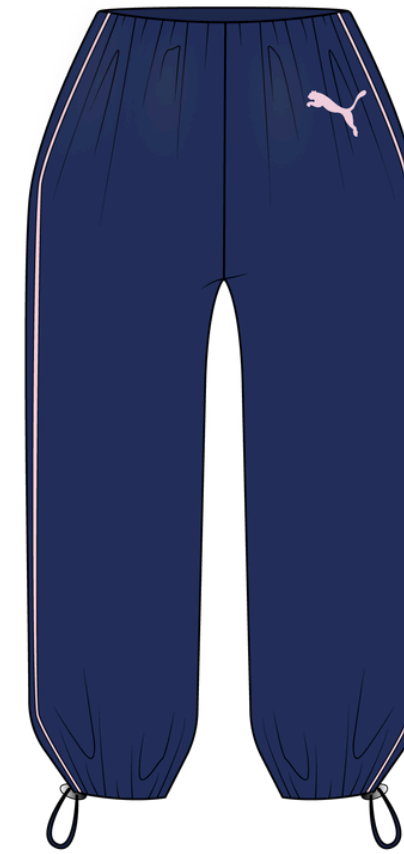

MIDNIGHT MOTION

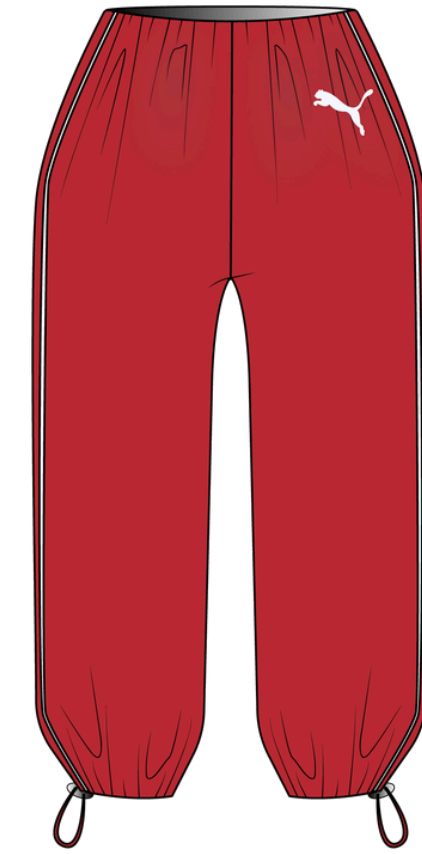

CHERRY STRIDE

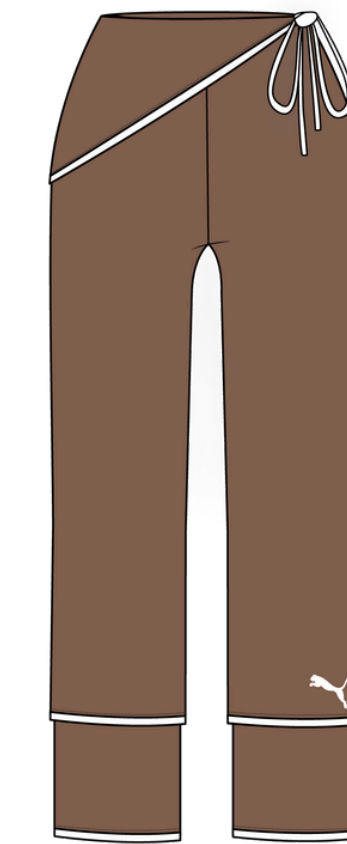

CLAY TRACK

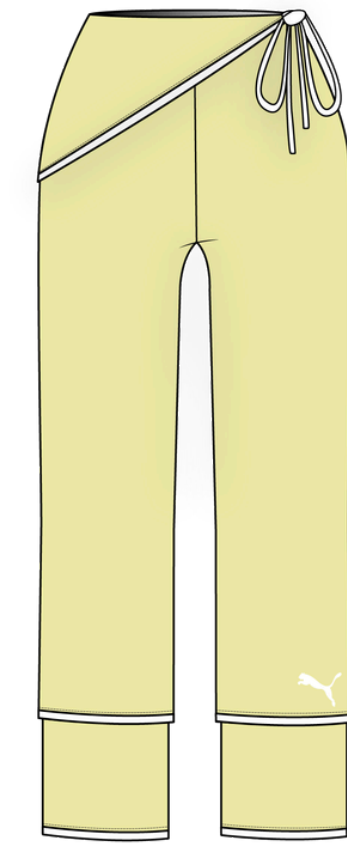

VICTORY YELLOW

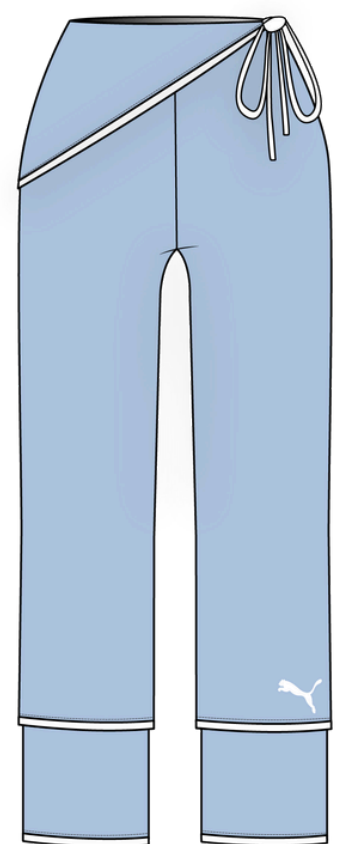

BASELINE BLUE

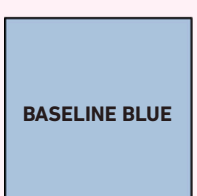
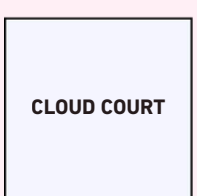

SOFT MOTION PUFF HOODIE



MIDNIGHT MOTION

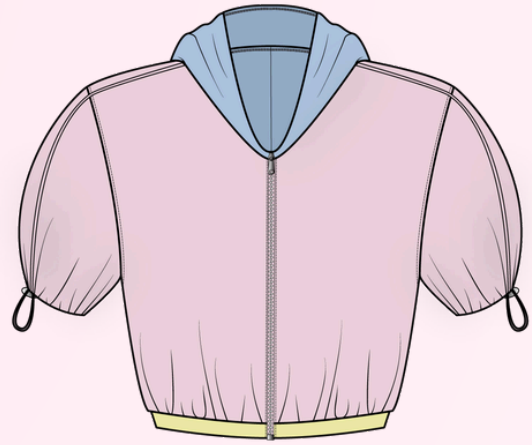

STUDIO PINK

SOFT MOTION LAYERED TEE



CLOUD COURT/BASELINE BLUE



MIDNIGHT MOTION/STUDIO PINK

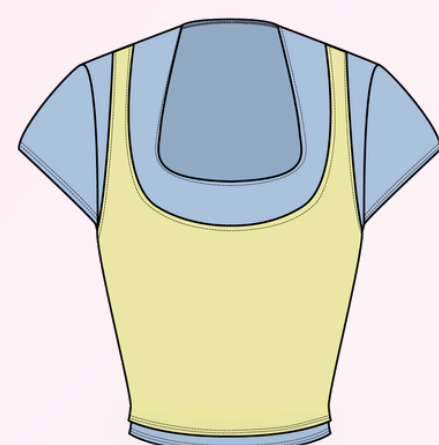

BASELINE BLUE/VICTORY YELLOW



CLOUD COURT/MULTI-STRIPE

SOFT MOTION CROPPED JERSEY



GREEN GREEN



MIDNIGHT MOTION



CLAY TRACK

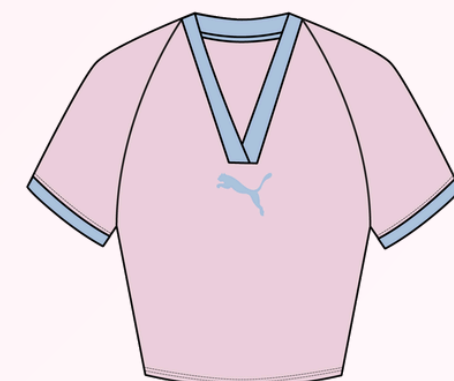

STUDIO PINK

SOFT MOTION LAYERED TRACK JACKET



STUDIO PINK



BASELINE BLUE

SOFT MOTION RUGBY SHIRT



MULTI-STRIPE



BASELINE BLUE